

SPICE thermal model

PSMN5R4-25YLD

Symbol	Parameter	Conditions	Min	Typ	Max	Unit
$R_{th(j-mb)}$	thermal resistance from junction to mounting base		-	-	3.22	K/W

C_{th1}	1.039E-05 F
C_{th2}	1.209E-04 F
C_{th3}	1.012E-04 F
C_{th4}	7.006E-04 F
C_{th5}	9.345E-04 F
C_{th6}	6.477E-03 F
C_{th7}	3.819E-02 F
C_{th8}	4.371E+01 F
R_{th1}	6.351E-03 Ω
R_{th2}	1.020E-02 Ω
R_{th3}	8.185E-02 Ω
R_{th4}	1.526E-01 Ω
R_{th5}	9.039E-01 Ω
R_{th6}	1.374E+00 Ω
R_{th7}	6.843E-01 Ω
R_{th8}	7.108E-03 Ω

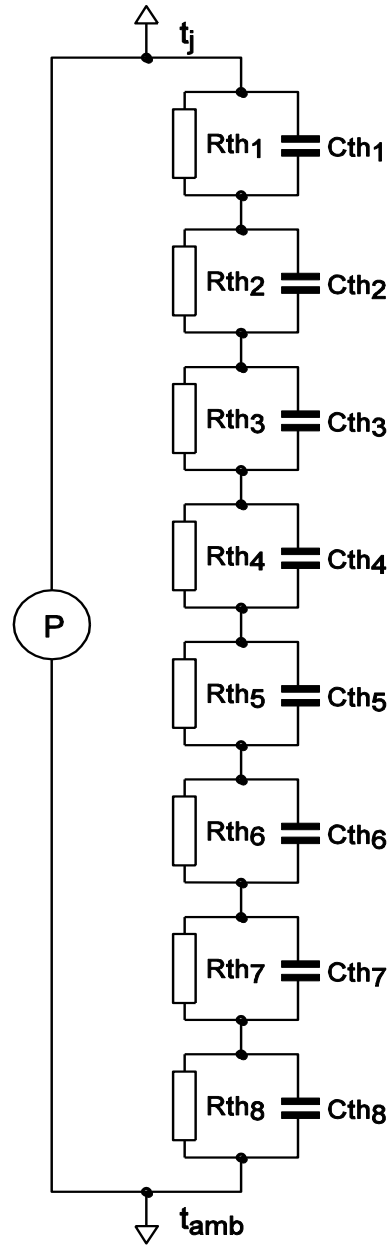

001aal768

Part: PSMN5R4-25YLD
 Date: 22/3/2016
 Model Rth 3.22 K/W